

D-5-55

Siphon Feed Detail Spray Gun

SHARPE

THE SPRAY GUN PEOPLE
FOR PRODUCT INFORMATION CALL:
1-800-742-7731



Important Safety Instructions

Read all warnings and instructions in this manual.
Save these instructions.

Maximum Air Inlet Pressure: 50 psi (345 kPa, 3.4 bar)

Part No. 7030 Spray Gun and 7510 Cup

For siphon feed spraying of automotive colors and clears. Ideal for touch-up and detail work.







SHARPE MANUFACTURING COMPANY • P.O. BOX 1441, MINNEAPOLIS, MN 55440-1441

1-800-742-7731, www.sharpe1.com

309991C, 4/2006

 **WARNING**

	<p>FIRE AND EXPLOSION HAZARD</p> <p>Flammable fumes, such as solvent and paint fumes, in work area can ignite or explode. To help prevent fire and explosion:</p> <ul style="list-style-type: none"> • Use equipment only in well ventilated area. • Eliminate all ignition sources; such as pilot lights, cigarettes, portable electric lamps, and plastic drop cloths (potential static arc). • Keep work area free of debris, including solvent, rags and gasoline. • Do not plug or unplug power cords or turn lights on or off when flammable fumes are present. • Ground equipment and conductive objects in work area. • If there is static sparking or you feel a shock, stop operation immediately. Do not use equipment until you identify and correct the problem.
	<p>EQUIPMENT MISUSE HAZARD</p> <p>Misuse can cause death or serious injury.</p> <ul style="list-style-type: none"> • Do not exceed the maximum working pressure or temperature rating of the lowest rated system component. See Technical Data in all equipment manuals. • Use fluids and solvents that are compatible with equipment wetted parts. See Technical Data in all equipment manuals. Read fluid and solvent manufacturer's warnings. • Check equipment daily. Repair or replace worn or damaged parts immediately. • Do not alter or modify equipment. • Use equipment only for its intended purpose. Call your Graco distributor for information. • Route hoses and cables away from traffic areas, sharp edges, moving parts, and hot surfaces. • Do not use hoses to pull equipment. • Keep children and animals away from work area. • Comply with all applicable safety regulations.
	<p>TOXIC FLUID OR FUMES HAZARD</p> <p>Toxic fluids or fumes can cause serious injury or death if splashed in the eyes or on skin, inhaled, or swallowed.</p> <ul style="list-style-type: none"> • Read MSDS's to know the specific hazards of the fluids you are using. • Store hazardous fluid in approved containers, and dispose of it according to applicable guidelines.
	<p>PERSONAL PROTECTIVE EQUIPMENT</p> <p>You must wear appropriate protective equipment when operating, servicing, or when in the operating area of the equipment to help protect you from serious injury, including eye injury, inhalation of toxic fumes, burns, and hearing loss. This equipment includes but is not limited to:</p> <ul style="list-style-type: none"> • Protective eyewear • Clothing and respirator as recommended by the fluid and solvent manufacturer • Gloves • Hearing protection
	<p>PRESSURIZED EQUIPMENT HAZARD</p> <p>Fluid from the gun/dispense valve, leaks, or ruptured components can splash in the eyes or on skin and cause serious injury.</p> <ul style="list-style-type: none"> • Follow Pressure Relief Procedure in this manual, when you stop spraying and before cleaning, checking, or servicing equipment. • Tighten all fluid connections before operating the equipment. • Check hoses, tubes, and couplings daily. Replace worn or damaged parts immediately.

2 Year Limited Warranty

Sharpe warrants this product to the original user against defective material or workmanship for a period of 1 year from the date of purchase.

Sharpe reserves the right to determine whether the part or parts failed because of defective material, workmanship, or other causes. Failures caused by accident, alteration, or misuse are not covered by this warranty.

Sharpe, at its discretion, will repair or replace products covered under this warranty free of charge. Repairs or replacements of products covered under this warranty are warranted for the remainder of the original warranty period.

Sharpe or its authorized service representatives must perform all warranty repairs. Any repair to the product by unauthorized service representatives voids this warranty. The rights under this warranty are limited to the original user and may not be transferred to subsequent owners.

This warranty is in lieu of all other warranties, expressed or implied, including warranties of merchantability and fitness for a particular purpose. Some states do not allow the exclusion or limitations of incidental or consequential damages, so the above limitations may not apply to you.

D-5-55 DETAIL SPRAY GUN

Setup

- Set shop air pressure regulator (not supplied) according to paint manufacturer's recommendation. Do not exceed 50 psi (345 kPa, 3.4 bar).
 - Make sure no air restrictions, such as low-volume cheater-valves, obstruct the air flow. If an air adjusting valve is desired, use a SHARPE Air Adjusting Valve 24AAV (part no. 2210), 36AAV-HOV (part no. 3310) or HOV (part no. U04410).
 - Install a shutoff valve (not supplied) downstream of the air regulator to shut off gun air.
 - Install an inline air filter (not supplied) to clean and dry the air supply to the gun.
1. Turn off air supply.
 2. Connect a clean, dry, filtered air supply to gun air inlet (2).
 3. If this is first time using the equipment, flush the spray gun.



FIG. 1

Operation

Pressure Relief Procedure

WARNING



Follow **Pressure Relief Procedure** when you stop spraying and before cleaning, checking, or servicing equipment. Read warnings, page 2.

1. Turn off gun air supply.
2. Trigger the gun to relieve pressure.

Flushing

WARNING



Read warnings, page 2.

Flush before using the equipment, before changing colors, and when you are done spraying. Use solvent that is compatible with gun wetted parts and fluid that will be sprayed. Flush at lowest possible pressure.



Refer to **Compliant Cleaning Methods**, page 4, to comply with air quality laws if applicable.

1. Follow **Pressure Relief Procedure**.
2. Dispose of any paint in cup.
3. Fill cup with small amount of solvent.
4. Spray into grounded metal waste container until equipment is clean.
5. Follow **Pressure Relief Procedure**.

Spraying

CAUTION

Excessive atomizing air pressure can increase over-spray, reduce transfer efficiency, result in a poor quality finish from dry spray.

1. Fill cup (101) with material. Do not fill past cup "shoulder" (A). See FIG. 1.
2. Screw cup (101) onto lid securely.
3. Slowly adjust gun air pressure while fully triggering the gun until you have the desired atomization.
4. Adjust the pattern size and shape with the spray width adjustment knob (10). See FIG. 2. Turn knob clockwise to reduce pattern size and counterclockwise to increase it.



See **Troubleshooting** guide if you experience an irregular pattern.

5. Fluid control knob (7) is factory set for maximum needle trigger travel and material flow. To decrease needle/trigger travel and decrease fluid flow, turn knob clockwise.

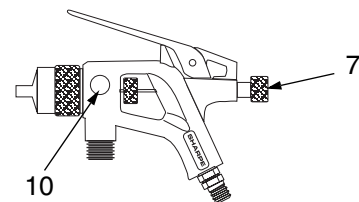

FIG. 2

Cleaning and Maintenance

WARNING



Follow **Pressure Relief Procedure** when you stop spraying and before cleaning, checking, or servicing equipment. Read warnings, page 2.

CAUTION

- Do not submerge gun in solvent. Solvent dissolves lubricant, dries out packings, and may clog air passages.
- Do not use metal tools to clean air cap holes as this may scratch them and distort the spray pattern.
- Use a compatible solvent.
- Gun and cup can be cleaned in a gun washer.



Clean air line filters as directed by the manufacturer.

Volatile Organic Compounds (VOC) Regulation

In certain states, spraying solvents that release VOC's into the atmosphere when cleaning a spray gun is prohibited. To comply with these air quality laws you must use a cleaning method that prevents the escape of VOC vapors into the atmosphere. See **Compliant Cleaning Methods** below.

Compliant Cleaning Methods

- Place spray gun in a gun washer that completely encloses the gun and components during cleaning, rinsing, and draining.
- Spray solvent through the spray gun into a closed gun cleaning station.

Cleaning Gun and Cup



Refer to **Compliant Cleaning Methods** to comply with air quality laws if applicable.

1. Follow **Flushing** procedure, page 3.
2. Use a rag moistened in solvent to wipe cup lid (109), fluid tube (103), inside of cup (101), and outside of gun.
3. Blow dry gun inside and out. Lubricate gun as described in **Spray Gun Maintenance**.

Cleaning Nozzle and Air Cap

CAUTION

- Trigger gun whenever you tighten or remove nozzle to avoid damaging needle seat and nozzle.
- Do not use metal tools to clean air cap holes as this may scratch them and distort the spray pattern.

To clean the air cap and nozzle, remove and soak them in a compatible cleaning solution. Clean them and front of gun with a soft-bristle brush dipped into compatible solvent. Do not use a wire brush or metal tools. To clean out air cap holes, use a soft implement, such as a toothpick.



Spray Gun Maintenance

- Frequently lubricate the gun moving parts with a drop of non-silicone oil (part no. 8255).
- Do not disassemble the spray gun if you are having a spray pattern problem. Check **Troubleshooting**, page 5, for information on how to correct the problem.
- Check for fluid leakage. Tighten fittings or replace equipment as needed.

Technical Data

Maximum Air Inlet Pressure: 50 psi (345 kPa, 3.4 bar)

Wetted Parts: stainless steel, aluminum, brass, LD polyethylene

Air Consumption: 4.1 scfm at 50 psi (345 kPa, 3.4 bar)

Spray Gun

- 1/4 npsm (R1/4-19) air inlet
- 1/4 npsm fluid inlet
- Weight - 8 oz. (227 grams)

Pressure cup: 6 oz. (177 cc)





Troubleshooting



WARNING

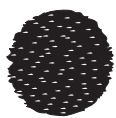

Follow **Pressure Relief Procedure**, page 3, before troubleshooting or servicing. Read warnings, page 2.

Problem	Cause	Solution
 Right	Normal pattern	No action necessary
 Wrong Heavy top or bottom pattern	Dirty or damaged air cap or fluid nozzle.	Rotate air cap 180°. <i>If pattern follows air cap</i> , problem is in air cap. Clean and inspect. If pattern is not corrected, replace air cap. <i>If pattern does not follow the air cap</i> , the problem is with the fluid nozzle. Clean and inspect the nozzle. If the pattern is not corrected, replace nozzle.
 Wrong Split pattern	Pressure too high for viscosity of material being sprayed.	a. Reduce air pressure. b. Increase material viscosity c. Correct pattern by narrowing fan size with spray width adjustment knob.
 Wrong	Dirty or distorted air horn holes.	Rotate air cap 180°. <i>If pattern follows air cap</i> , problem is in air cap. Clean and inspect. If pattern is not corrected, replace air cap.
Will not spray.	a. Cup is not tight b. Cup empty. c. Air cap not seated.	a. Tighten cup lid. b. Fill cup. c. Turn spray width adjustment knob fully counterclockwise. Tighten air cap.
 Wrong Heavy pattern or orange peel	a. Air pressure too low. b. Gun held too close to surface.	a. Increase air pressure. b. Hold gun about 6-8 inches (150-200 mm) from surface.

D-5-55 DETAIL SPRAY GUN

Parts

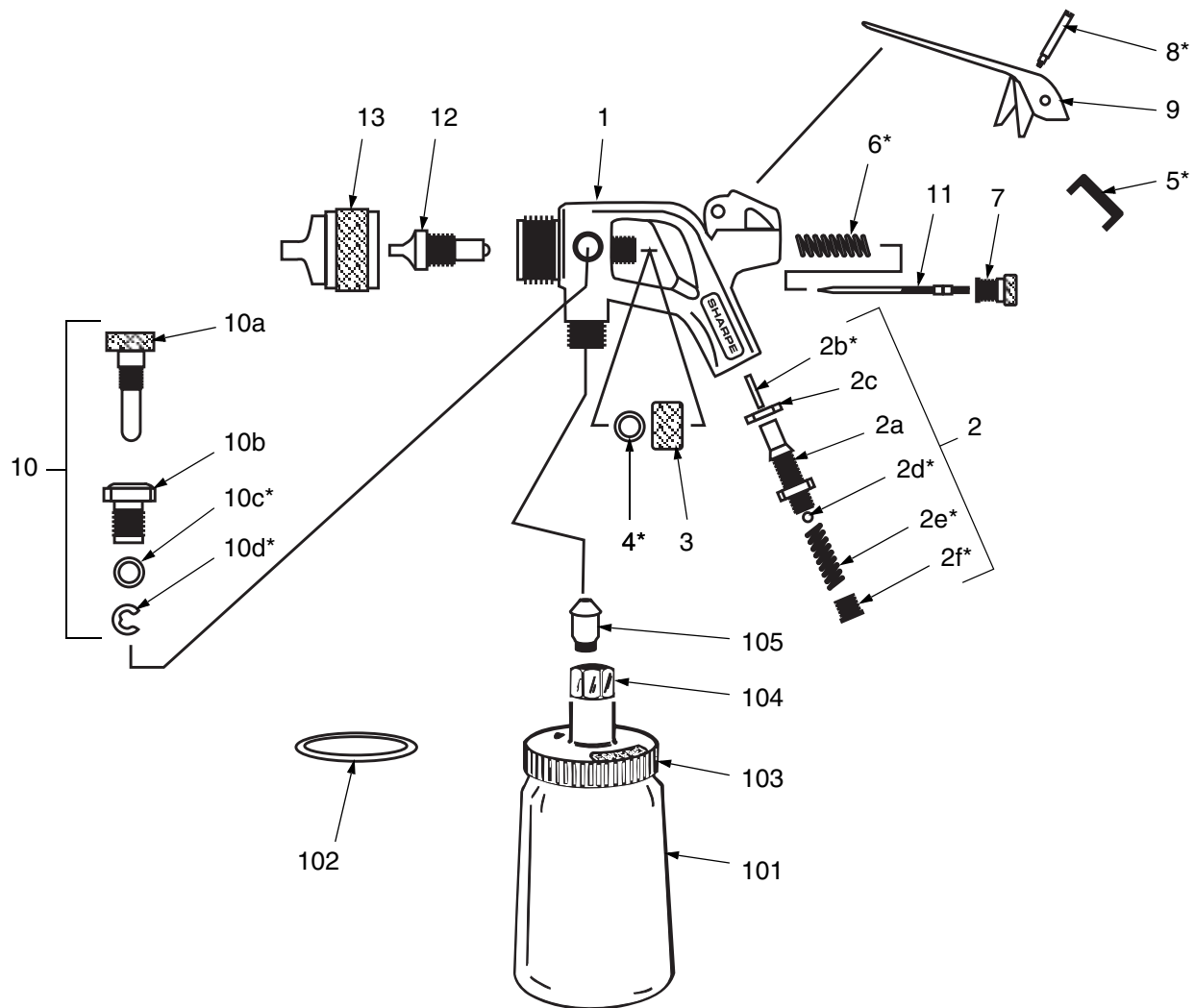

Part No. 7030, D-5-55 Detail Spray Gun

Ref. No.	Part No.	Description	Qty.
1	29001	Gun Body	1
2	29054	Air Valve Assembly Includes items 2a-2f	1
2a	34819	• Housing	1
2b*	29049	• Air Valve Stem	1
2c	29053	• Lock Nut	1
2d*	29050	• Ball	1
2e*	29036	• Needle Spring	1
2f*	29052	• Retainer	1
3	29033	Needle Packing Nut	1
4*	26022	Needle Packing	1
5*	29047	Plunger	1
6*	29036	Needle Spring	1
7	29046	Fluid Control Knob	1
8*	29056	Trigger Screw	1
9	29055	Trigger	1
10	29030	Width Control Assembly Includes items 10a-10d	1
10a	118749	• Knob	1

Ref. No.	Part No.	Description	Qty.
10b	118741	• Packing Nut	1
10c*	29028	• Packing	1
10d*	29029	• Retaining Ring	1
11	29041	Fluid Needle	1
12	29021	Fluid Nozzle, 0.55	1
13	29006	Air Cap	1

* Parts included in Repair Kit 29086.

Part No. U07510, D-500 Cup Assembly

Ref. No.	Part No.	Description	Qty.
101	U07530	Cup with air-tight cover	1
102	29063	Gasket, pack of 5	1
103	29062	Lid with Fluid Tube	1
104	29057	Coupling Nut	1
105	29058	Nipple Fitting	1